

TECNIMETAL

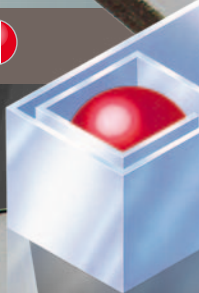

RASCHIAOLIO
WAY WIPERS
ABSTREIFER
RACLEURS DE GLISSIÈRES

PROFILO TECNIMETAL

TECNIMETAL, con sede in S. Giovanni in Croce - Cremona, operante nella costruzione di articoli tecnici per macchine utensili dal 1974, è costantemente impegnata nella ricerca e nelle innovazioni produttive, unitamente ad una tradizione di qualità ed affidabilità, che ha determinato un progressivo sviluppo dell'azienda ed una sua affermazione nel mercato nazionale ed internazionale.

Esperienza, specializzazione e conoscenza delle problematiche dei clienti, sono il fondamento dell'ufficio tecnico.

I più avanzati strumenti di calcolo e progettazione, danno luogo a nuovi layout di prodotti, che offrono soluzioni tecniche mirate alle diverse esigenze.

I nostri tecnici sono al servizio del cliente dalla fase iniziale dello studio di un progetto fino alla fase della messa in servizio.

Lavorando prevalentemente su commessa, l'azienda ha sviluppato una flessibilità tale che le permette di costruire nella sua gamma di prodotti, qualsiasi tipo di attrezzatura speciale, nel settore della macchina utensile.

All'interno dello stabilimento si sviluppa l'intero ciclo produttivo che parte dalle materie prime ed arriva al prodotto finito.

La produzione "TECNIMETAL" comprende i seguenti articoli:

- Protezioni a soffietto;
- Protezioni a nastro;
- Convogliatori di trucioli;
- Protezione telescopiche in lamiera d'acciaio speciale;
- Catene portacavi;
- Protezioni telescopiche a spirale;
- Raschiaolio in barre e sagomati;
- Protezioni a tapparella.

L'accurata selezione dei materiali titolati, la professionalità del personale, le avanzate tecniche produttive e la serietà commerciale sono le ragioni del successo TECNIMETAL.

Un successo che trova riscontro nelle numerose macchine ed impianti operanti in Italia e in tutto il mondo.

TECNIMETAL, la scelta dell'affidabilità.



TECNIMETAL PROFILE

TECNIMETAL, headquartered in S. Giovanni in Croce - Cremona, has been a top manufacturer of machine tool accessories since 1974, and is constantly engaged in research and product innovation, together with a tradition of quality and reliability, which has propelled TECNIMETAL's progressive expansion into the national and international markets.

Experience, specialization, and a clear understanding of costumers concerns are the basis of the technical department.

Advanced calculation and design instruments give rise to new products, which offer technical solutions for a vast number of requirements.

Our Technicians keep client concerns and needs in mind from the beginning of a design study to the actual installation of the equipment.

Working primarily on custom-made products, our company is among the most versatile in the world, allowing us to design and manufacture nearly any kind of special equipment in the machine tools field.

TECNIMETAL's range includes the following products:

- Bellow covers;
- Roll up covers;
- Chip conveyors;
- Steel telescopic way covers;
- Cable carriers;
- Helical metal spring guards;
- Way wipers;
- Apron covers.

The accurate selection of high quality materials, the close attention to detail, and the flexibility of our customer solutions, compounded by our professional and curteous staff and commercial dedication, make TECNIMETAL a leader of the industry. Our expertise in equipment design, manufacture and implementation can be found in installations throughout Italy and the rest of the world.

TECNIMETAL is the choice of reliability.



INDICE

INDEX



RASCHIAOLIO

WAY WIPERS

ABSTREIFER

RACLEURS DE GLISSIÈRES

4

RASCHIAOLIO TIPO AS LINEARI O SAGOMATI

WAY WIPERS AS TYPE LINEAR OR SHAPED

ABSTREIFER TYP AS LINEAR ODER GEFORMT

RACLEURS DE GLISSIÈRES TYPE AS LINÉAIRES OU FAÇONNÉS

5

RASCHIAOLIO PER PROTEZIONI TELESCOPICHE

WIPERS FOR TELESCOPIC COVERS

ABSTREIFER FÜR TELESKOPABDECKUNGEN

RACLEURS POUR PROTECTEURS TÉLESCOPIQUES

7

RASCHIAOLIO TIPO AZ LINEARI O SAGOMATI

WAY WIPERS AZ TYPE INEAR OR SHAPED

ABSTREIFER TYP AZ LINEAR ODER GEFORMT

RACLEURS DE GLISSIÈRES TYPE AZ LINÉAIRES OU FAÇONNÉS

8



RASCHIAOLIO

WAY WIPERS

ABSTREIFER

RACLEURS DE GLISSIÈRES

CARATTERISTICHE

RASCHIAOLIO PER GUIDE

I raschiaolio o raschiasporco TECNIMETAL sono stati concepiti per soddisfare le seguenti esigenze tecniche:

- Impermeabilità e insensibilità all'azione degli olii e dei prodotti chimici di refrigerazione.
- Resistenza all'usura causata dal persistente ed elevato attrito durante l'azione di raschiatura.
- Garanzia di elasticità duratura nel tempo.
- Facile intercambiabilità.
- Aderenza perfetta su tutto il lato raschiante.

Dopo anni di ricerche di mercato e continui contatti con gli uffici tecnici di innumerevoli costruttori di macchine utensili, abbiamo approntato la nostra gamma di raschiaolio nel modo seguente:

TIPO AS - TIPO AZ

FEATURES

WAY WIPERS

TECNIMETAL way wipers have been designed to meet the following technical requirements:

- Impermeability and insensitivity to the action of oils and chemical refrigeration products.
- Resistance to wear from the persistent and elevated friction during the wiping action.
- Guarantee of elasticity through the time.
- Easily interchangeable.
- Perfect adherence of the whole wiping side.

After years of market research and continuous contact with several technical departments of machine-tools builders, we present our range of way wipers as follows:

TYPE AS - TYPE AZ

EIGENSCHAFTEN

FÜHRUNGSBAHNABSTREIFER

Die Abstreifer TECNIMETAL wurden entwickelt, um die folgenden technischen Ansprüche zu erfüllen:

- Impermeabilität und Unempfindlichkeit gegenüber der Einwirkung von Ölen und chemischen Kühlprodukten.
- Beständigkeit gegen Abnutzung, die von der andauernden und hohen Reibung während der Schabung verursacht wird.
- Garantierte, dauerhafte Elastizität.
- Leichte Auswechselbarkeit.
- Perfektes Haftvermögen an der schabenden Seite.

Nach jahrelangen Marktforschungen und kontinuierlichen Kontakten mit zahlreichen Konstrukteuren von Werkzeugmaschinen, haben wir unser Sortiment von Abstreifern wie folgt fertiggestellt:

TYPE AS - TYPE AZ

CARACTÉRISTIQUES

RACLEURS DE GLISSIÈRES

Les racleurs de glissières TECNIMETAL ont été conçus pour satisfaire les exigences techniques suivantes:

- Imperméabilité à l'action des huiles et des produits chimiques de réfrigération.
- Résistance à l'usure causée par le frottement persistant et élevé pendant l'action de raclage.
- Garantie d'élasticité durable dans le temps.
- Intercambiabilité facile.
- Adhérence parfaite sur tout le côté raclant.

Après des années de recherches de marché et de contacts continus avec les bureaux techniques d'innombrables constructeurs de machines-outils, nous avons apprêté notre gamme de racleurs de la façon suivante:

TYPE AS - TYPE AZ



RASCHIAOLIO TIPO AS LINEARI O SAGOMATI

WAY WIPERS AS TYPE LINEAR OR SHAPED
ABSTREIFER TYP AS LINEAR ODER GEFORMT
RACLEURS DE GLISSIERES TYPE AS LINÉAIRES OU FAÇONNÉS

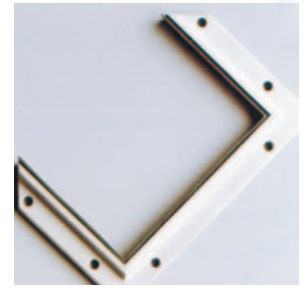

CARATTERISTICHE

Con questa serie di raschiaolio risolviamo finalmente il problema della costruzione di piccole quantità senza ricorrere a costosi stampi e attendere consegne con scadenze lunghe ed incerte.

Dati tecnici:

È composto da un mantello esterno in acciaio inox Aisi 304 che protegge il profilo in gomma sintetica a base di poliuretano.

Resiste a: olio, liquido refrigerante acido o basico, trucioli caldi, mantenendo inalterata la flessibilità nel tempo.

Prearica: per guide normali da 0,8 a 1 mm.
per guide idrostatiche 0,5 mm.

I raschiaolio tipo AS possono essere forniti in listelli lunghi 500 mm, oppure sagomati in base al disegno del cliente.

Ecco alcuni esempi di profili realizzati.

Montaggio: per fissare il raschiaolio tipo AS è consigliabile usare viti UNI 2383 ed esercitare una pressione tale da non deformare il mantello di acciaio.

FEATURES

With this series of way wipers, we finally resolve the problem of small productions without making any expensive mold and with no more long and uncertain delivery times.

Technical Data:

It is composed of an external mantle of Aisi 304 stainless steel, which protects the profile of synthetic rubber with a base of polyurethane.

It resists to: oils, acid or basic coolant liquids, hot shavings, keeping its flexibility through the time.

Preloading: for normal guides from 0,8 to 1 mm.
for hydrostatic guides 0,5 mm.

The AS type way wipers can be supplied with ledges 500 mm long, or shaped according to customers design.

Here are some examples of realizable profiles.

Set up: to fix the AS way wiper it is advisable to use UNI 2383 screws and to push softly in order to prevent the steel profile from deformation.

Ecco alcuni esempi di profili realizzati:
Here are some examples of realizable profiles:
Hier sind einige Beispiele der von uns hergestellten Profile:
Voici quelques exemples de profils réalisés:

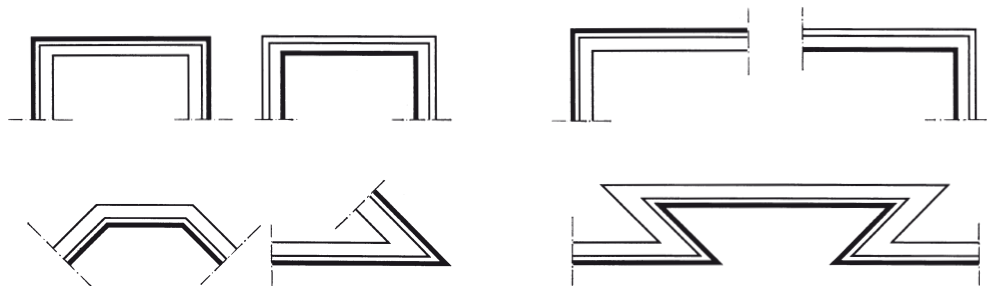

EIGENSCHAFTEN

Mit dieser Serie von Abstreifer werden wir endlich das Problem der Konstruktion von kleinen Mengen lösen, ohne auf kostspielige Werkzeuge zurückgreifen zu müssen und auf lange und unsichere Liefertermine warten zu müssen.

Technische Daten:

Aussenmantel aus InoxStahl Aisi 304 der das Profil in synthetischem Gummi auf Polyurethanbasis schützt.

Beständig gegen: Öl, saure oder basische Kühlflüssigkeit, heiße Späne, durch Erhaltung von dauerhafter Elastizität.

Vorspannung:

für normale Führungsbahn von 0,8 mm. bis 1 mm.
für hydrostatische Führungsbahn 0,5 mm.

Die Abstreifer Typ AS können in 500 mm. langen Leisten oder gemäß Profilzeichnung des Kunden geliefert werden.

Nachstehend einige Beispiele.

Montage: um den Abstreifer Typ AS zu befestigen ist es erforderlich Schrauben UNI 2383 einzusetzen und einen solchen Druck auszuüben, dass der Stahlmantel nicht verbogen wird.

CARACTÉRISTIQUES

Avec cette série de racleurs nous résolvons finalement le problème de construction de petites quantités sans recourir à des étampes coûteuses et attendre des livraisons à échéances longues et incertaines.

Fiche Technique:

Il est composé d'une enveloppe extérieure en acier inox Aisi 304 qui protège le profil en caoutchouc synthétique à base de polyuréthane.

Il résiste: à l'huile, au liquide réfrigérant acide ou basique, aux copeaux chauds, en maintenant inaltérée la flexibilité dans le temps.

Précharge: pour glissières normales de 0,8 à 1 mm.
pour glissières hydrostatiques 0,5 mm.

Les racleurs de type AS peuvent être fournis en barres longues de 500 mm. ou bien façonnés sur la base du dessin du client.

Voici quelques exemples de profils réalisés.

Montage: pour fixer le racleur de type AS il est recommandable d'utiliser des vis UNI 2383 et exercer une pression de manière à ne pas déformer l'enveloppe en acier.

TIPO AS - AS TYPE

AS2

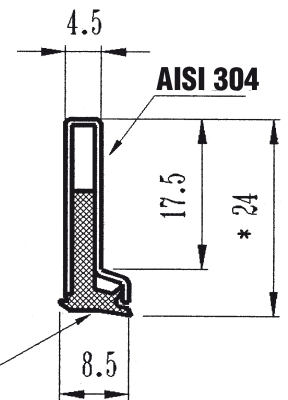
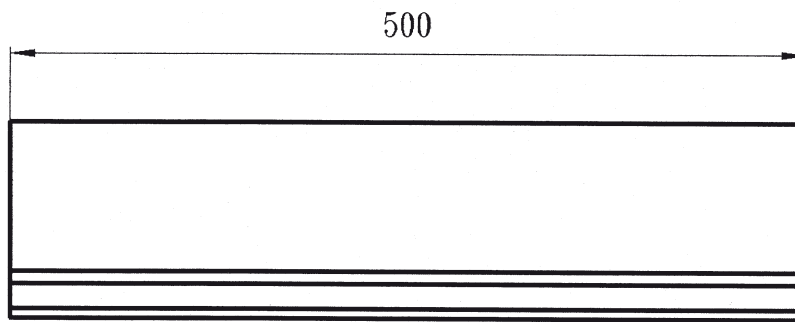

POLIURETANO PUR 90A
POLYURETHANE PUR 90A

AS2R

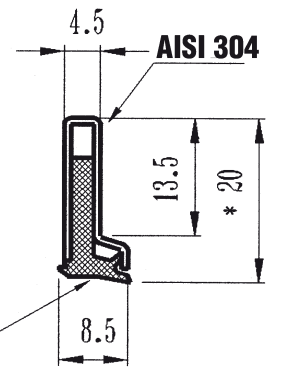
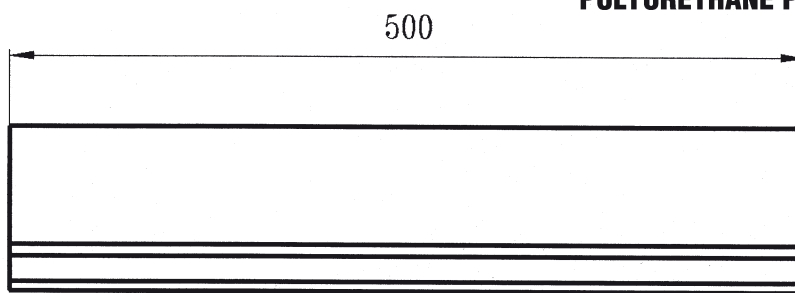

POLIURETANO PUR 90A
POLYURETHANE PUR 90A

AS1

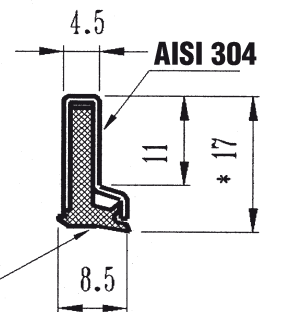
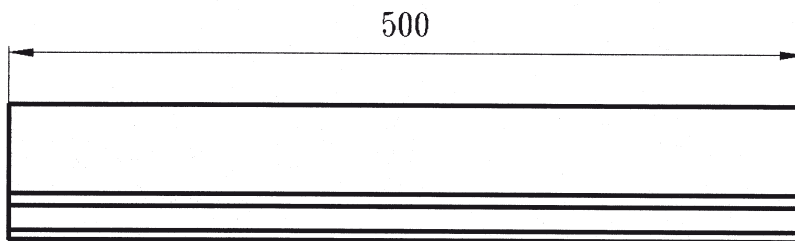

POLIURETANO PUR 90A
POLYURETHANE PUR 90A

AS1R

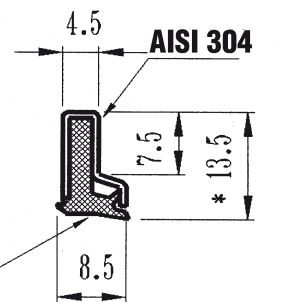
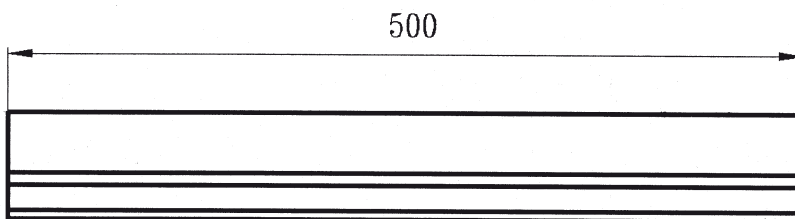

POLIURETANO PUR 90A
POLYURETHANE PUR 90A

AS1XR

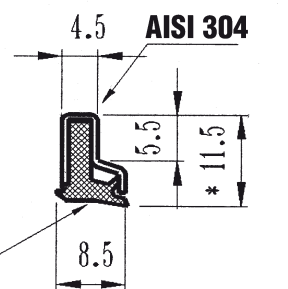
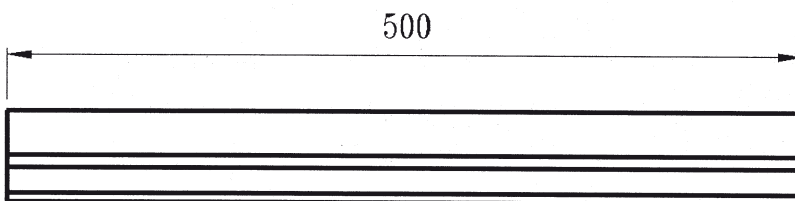

POLIURETANO PUR 90A
POLYURETHANE PUR 90A



RASCHIAOLIO PER PROTEZIONI TELESCOPICHE

WIPERS FOR TELESCOPIC COVERS

ABSTREIFER FÜR TELESKOPABDECKUNGEN

RACLEURS POUR PROTECTEURS TÉLESCOPIQUES

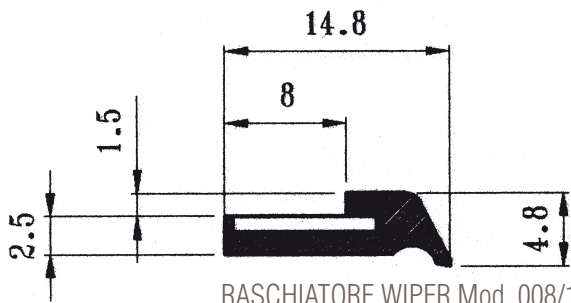

RASCHIATORE WIPER Mod. 008/11109
 Materiale Acciaio-NBR
 Material Steel-NBR
 In barre / Bars Length 560 mm

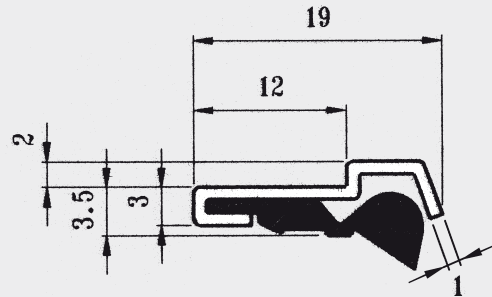

RASCHIATORE WIPER Mod. 008/11111
 Materiale Acciaio-Poliuretano
 Material Steel-Polyurethane
 In barre / Bars Length 3000 mm

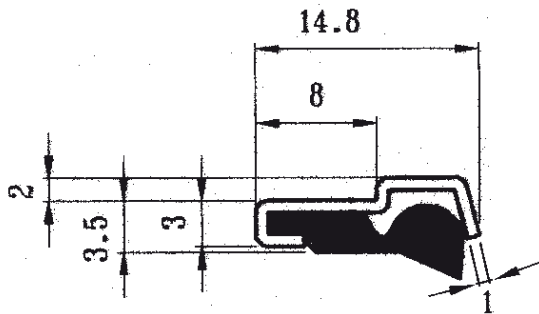

RASCHIATORE WIPER Mod. 008/45700
 Materiale Acciaio-Poliuretano
 Material Steel-Polyurethane
 In barre / Bars Length 3000 mm

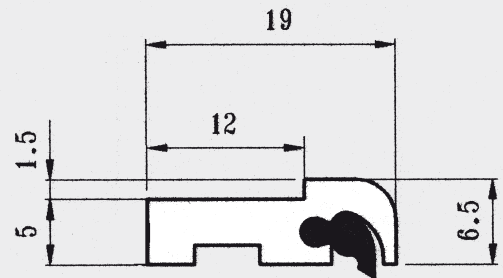

RASCHIATORE WIPER Mod. 008/32447
 Materiale Ottone-Poliuretano
 Material Brass-Polyurethane
 In barre / Bars Length 3000 mm

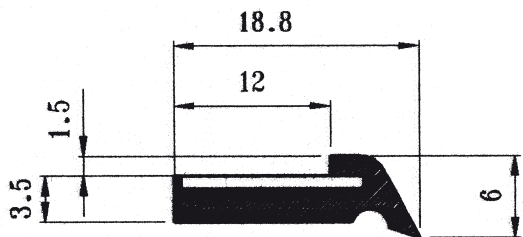

RASCHIATORE WIPER Mod. 008/11110
 Materiale Acciaio-NBR
 Material Steel-NBR
 In barre / Bars Length 560 mm

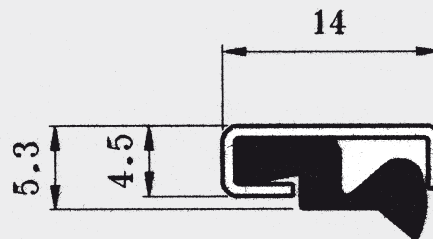

RASCHIATORE WIPER Mod. 008/40295
 Materiale Acciaio-Poliuretano
 Material Steel-Polyurethane
 In barre / Bars Length 560 mm

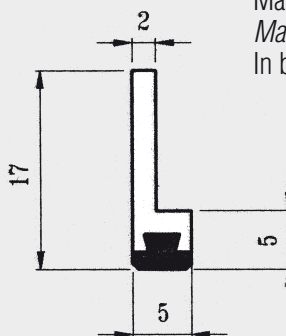

RASCHIATORE SHOE Mod. 004/47163
 Materiale Ottone-Poliuretano
 Material Brass-Polyurethane
 In barre / Bars Length 380 mm

RASCHIAOLIO TIPO AZ LINEARI O SAGOMATI

WAY WIPERS AZ TYPE INEAR OR SHAPED

ABSTREIFER TYP AZ LINEAR ODER GEFORMT

RACLEURS DE GLISSIÈRES TYPE AZ LINÉAIRES OU FAÇONNÉS



CARATTERISTICHE

Dati Tecnici:

È composto da un profilo in gomma sintetica a base di poliuretano vulcanizzata su piatto d'acciaio A 37.

Resiste a: olio e liquido refrigerante acido o basico.

Pre carica: 0,5 mm.

Il raschiaolio tipo AZ può essere fornito in barre lunghe 560 mm. (AZ13 IL. 500 mm.) con le seguenti dimensioni:

FEATURES

Technical Data:

It is composed of a synthetic rubber profile with a base of polyurethane vulcanized on A 37 steel plate.

It resists to: oils and acid or basic coolant liquids.

Preloading: 0,5 mm.

The AZ way wipers can be supplied with ledges 560 mm. long (AZ13 L. 500 mm.) with the following dimensions:

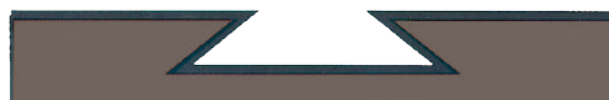
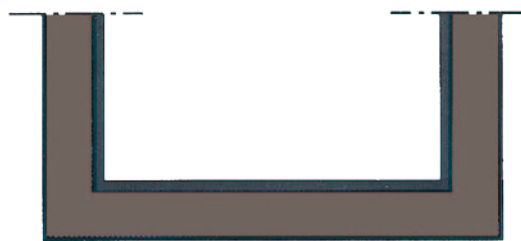
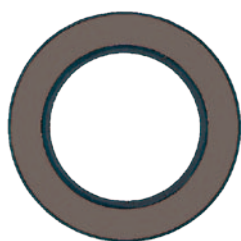
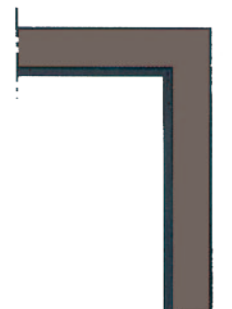
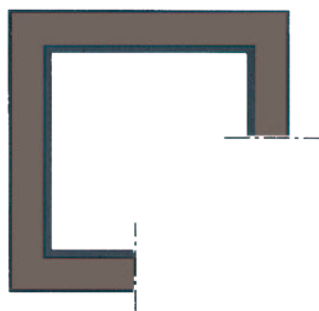
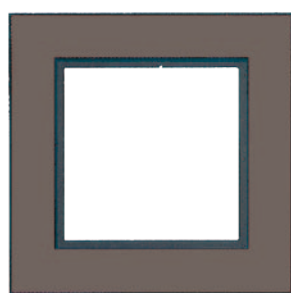

*Oppure con forma sagomata su disegno del cliente. Ecco alcuni esempi:
Or formed on the base of the clients design. Here are some examples:
Oder gemäß Profilzeichnung des Kunden. Hier einige Beispiele:
Ou bien façonné sur la base du dessin du client. Voici quelques exemples:*

EIGENSCHAFTEN

Technische Daten:

Bestehend aus syntethischem Gummiprofil auf Polyurethanbasis vulkanisiert auf Stahlteller A 37.

Beständig gegen: Öl und saurer oder basischer Kühlflüssigkeit.

Vorspannung: 0,5 mm.

Der Abstreifer AZ kann in 560 mm. (AZ13 L. 500 mm.) langen Stäben geliefert werden mit folgenden Abmessungen:

CARACTÉRISTIQUES

Fiche Technique:

Il est composé d'un profil en caoutchouc synthétique à base de polyuréthane vulcanisé sur un plat d'acier A 37.

Il résiste à: l'huile et au liquide réfrigérant acide ou basique.

Précharge: 0,5 mm.

Le racleur AZ peut être fourni en barres longues de 560 mm. (AZ13 IL. 500 mm.) avec les dimensions suivantes:

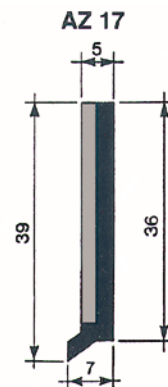
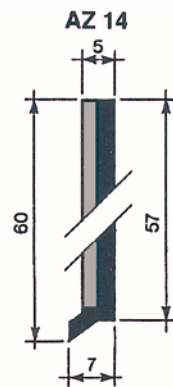
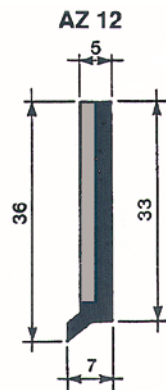
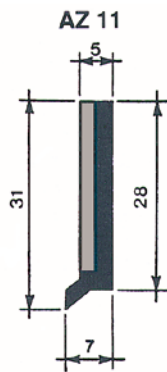
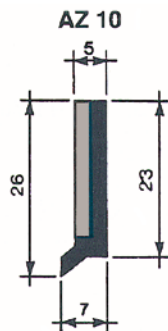
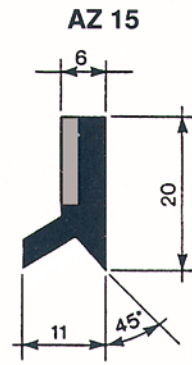
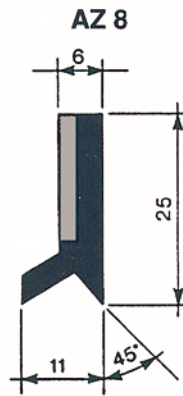
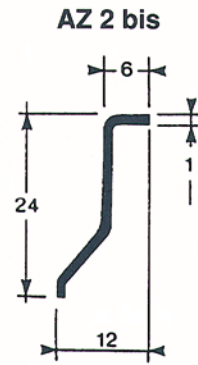
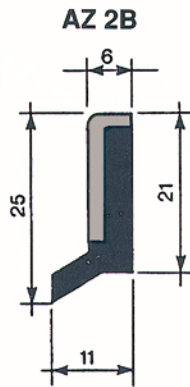
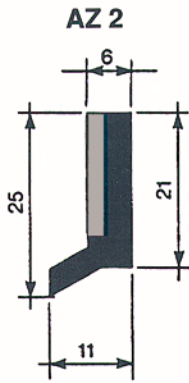
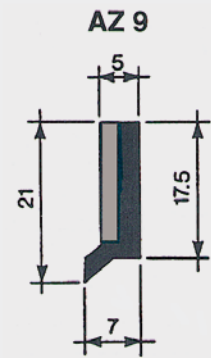
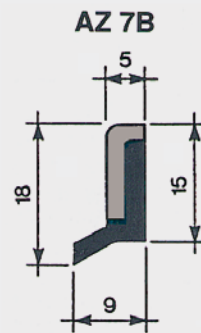
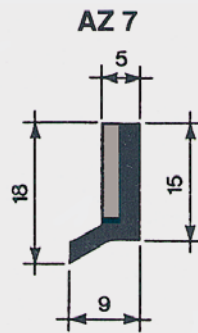
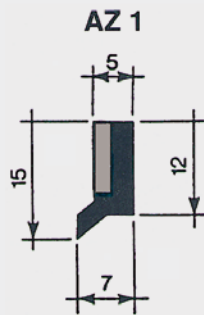
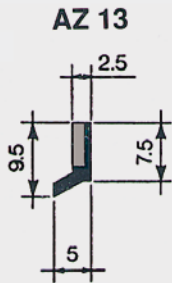
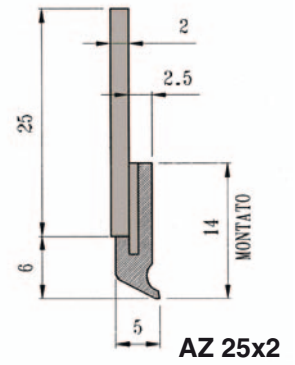
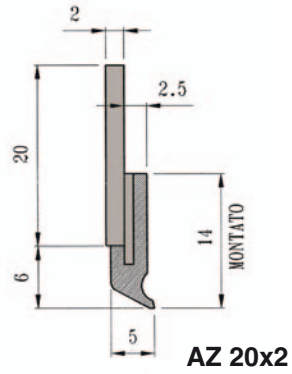
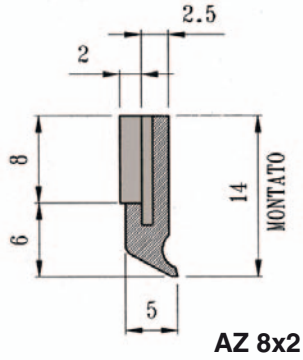
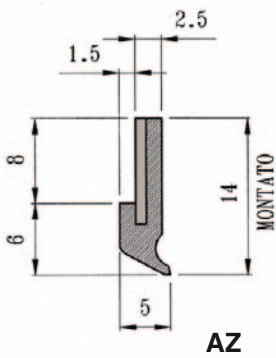

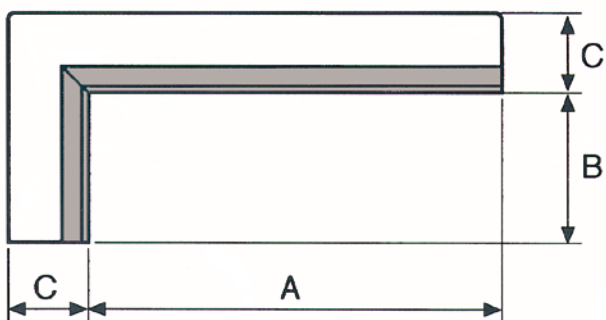

CARATTERISTICHE

Abbiamo disponibili gli stampi per realizzare le seguenti sagome, con le relative varianti dimensionali.

EIGENSCHAFTEN

Wir verfügen über die Werkzeuge für die Herstellung der folgenden Profile, mit entsprechenden Massvarianten.

A mm.	B mm.	C mm.	SIGLA
86	20	15	B 2
59	34	15	B 3
125	45	15	B 5
43	33	17	B 9
68	31	25	B 11
86	30	20	B 12
100	40	25	B 14
175	50	25	B 15
125	50	25	B 16
37	57	22	B 21
75	38	25	B 22
125	40	25	B 23
29	18	15	B 68
100	50	25	B 28
50	30	14	B 29
90	70	15	B 34
93	18	23	B 35
20	20	12	B 53
150	40	15	B 38
114	84	23	B 39
150	40	20	B 40
75	40	25	B 41
80	30	25	B 42
120	30	15	B 44
200	140	25	B 46
40	30	20	B 47
30	25	20	B 48
135	45	15	B 49
70	20	15	B 50
50	44	15	B 51
77	30	15	B 52
70	40	22	D 129

A mm.	B mm.	C mm.	
55	24	94	
75	28	117	
105	28	146	
100	39	153	
89	30	131	
64	28	112	
80	27	110	
106	26	175	
90	28	140	
100	28	150	
120	28	170	
130	30	180	
108	20	149	
130	32	180	
68	24	114	
150	30	200	
60	20	138	
70	28	100	
110	30	160	
80	36	130	
110	32	160	
30	25	60	
40	25	70	
50	25	80	
128	210	164	
35	20	75	
85	35	145	
290	40	340	
130	43	180	
60	30	100	
132	107	159	
90	45	118	
340	45	392	
28	16	52	
45	35	85	
70	48	130	
40	20	64	
35	20	39	
35	40	95	



FEATURES

We have the molds at our disposal to manufacture the following models with the relative changing dimensions.

CARACTÉRISTIQUES

Nous avons à disposition les outillages pour réaliser les profils suivants, avec les variantes dimensionnelles correspondantes.

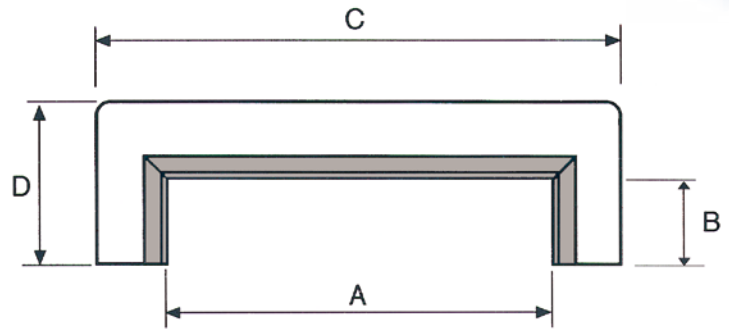

D mm.	SIGLA	A mm.	B mm.	C mm.	D mm.	SIGLA
43	C 1	28	26	62	43	C 531
49	C 2	25	33	55	48	C 533
49	C 3	160	71	200	91	C 537
63	C 4	80	32	114	49	C 563
51	C 5	350	450	400	478	C 567
41	C 6	70	35	130	65	C 587
42	C 7	100	45	140	65	C 589
60	C 9	80	36	120	56	C 601
53	C 26	85	40	125	60	C 620
53	C 27	110	67	160	92	C 625
53	C 28	50	20	90	42	C 626
55	C 35	65	23	101	40	C 630
40	C 47	85	40	119	57	C 631
58	C 85	200	200	296	248	C 642
57	C 87	125	56	165	76	C 647
59	C 88	45	18	75	35	C 648
43	C 90	63	28	103	48	C 655
42	C 93	119	17	47	31	C 666
55	C 124	48	17	77	32	C 667
61	C 128	39	13	68	28	C 668
57	C 146	45	25	69	37	C 671
60	C 147	250	45	300	70	C 672
60	C 148	200	200	247	247	C 677
60	C 149	40	34	100	68	C 686
228	C 155	50	30	85	47	C 694
45	C 158	70	30	105	47	C 695
60	C 162	100	45	135	62	C 696
65	C 163	20	12	44	24	C 708
68	C 170	205	137	235	152	C 723
50	C 177	93,5	100	151	129	C 733
119	C 178	75	40	119	62	C 746
59	C 181	258	176	305	200	C 776
71	C 195	135	55	171	73	C 795
28	C 220	100	40	150	65	C 811
55	C 221	125	56	165	76	C 838
78	C 222	65,5	30,5	97,5	46,5	C 843
32	C 226	40	20	74	36	C 859
32	C 227	404	60		81,6	C 863
70	C 232	160	35	210	60	C 892
		63	28	103	48	C 896
		37,5	28	74	50	C 929

PROGRAMMA DI VENDITA

SALES PROGRAMME

LIEFERPROGRAMM

PROGRAMME DE VENTE



Protezioni telescopiche
Telescopic covers
Teleskopabdeckungen
Protecteurs telescopiques

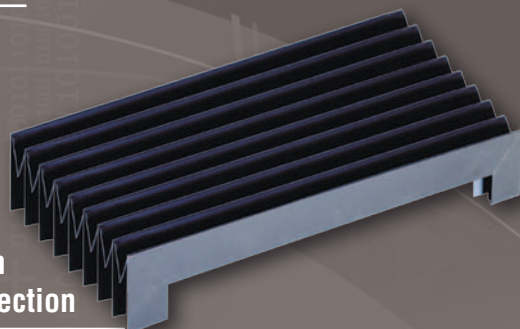

Protezioni a soffiutto
Bellows
Balgenabdeckungen
Soufflets de protection

Convogliatori di Trucioli
Chip conveyors
Späneförderer
Convoyeurs à copeaux

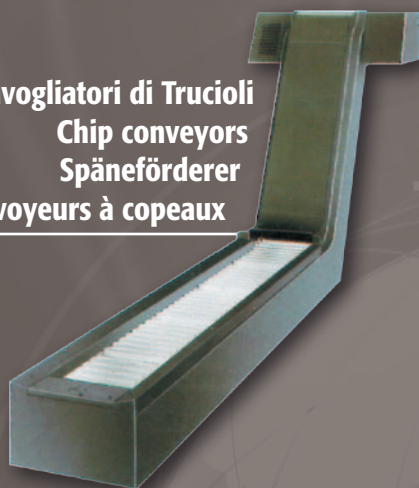

Protezioni a nastro
Roll Up covers
Rolloabdeckungen
Protecteurs à bande

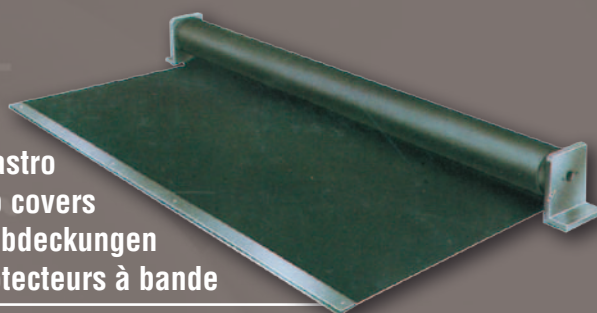

Molle a spirale
Helical metal spring guards
Teleskop-federn
Ressorts helicoidaux



Catene portacavi
Cable carriers
Energieführungsketten
Chaînes porte-cables



TECNIMETAL

26037 SAN GIOVANNI IN CROCE (CR) | ITALY
Tel. +39 0375 310082 r.a. Fax +39 0375 91538
www.tecnimetal.com | e-mail: info@tecnimetal.com